

40870 - Douglas Blokhut Curaçao

Ordernummer	-
Afmetingen (cm)	282,5 x 282,5 Breedte x diepte

Aantal	Code	Lengte (mm)	Omschrijving
1	WDB01 - 283		Voorwand met dubbele deur
1		2825x555	Douglas Blokhutprofiel wb180 Gevelpunt (3 planken)
22		593	Douglas Blokhutprofiel wb180
1	WDB03 - 283		Achterwand
1		2825x555	Douglas Blokhutprofiel wb180 Gevelpunt (3 planken)
11		2825	Douglas Blokhutprofiel wb180
1	WDB04 - 283		Zijwand met raam
1		3575	Douglas Blokhutprofiel wb180 zonder veer
4		985	Douglas Blokhutprofiel wb180
1		1418	Douglas Blokhutprofiel wb180
1		1201	Douglas Blokhutprofiel wb180
2		985	Douglas Blokhutprofiel wb180
6		2825	Douglas Blokhutprofiel wb180
1		2825	Douglas Blokhutprofiel wb180, H=105 (zonder groef)
1	WDB05 - 283		Zijwand dicht
1		3575	Douglas Blokhutprofiel wb180 zonder veer
1		3258	Douglas Blokhutprofiel wb180
1		3042	Douglas Blokhutprofiel wb180
8		2825	Douglas Blokhutprofiel wb180
1		2825	Douglas Blokhutprofiel wb180, H=105 (zonder groef)
3	GDB01 - 283	3575	Gording Douglas 45x160
4	WDB01 - 283	1650	Windveer Douglas 18x78
4	BDB01 - 283	1650	Boeiboord Douglas 18x160
68	DDB01 - 283	1625	Douglas Dakhout 16mm dik werkende breedte 108
1	40800	1640x1970	Douglas dubbele deur 8-ruits
1	40820	850x640	Douglas uitzetraam 6-ruits
1			Bevestigingsmateriaal
5		pak	Shingles

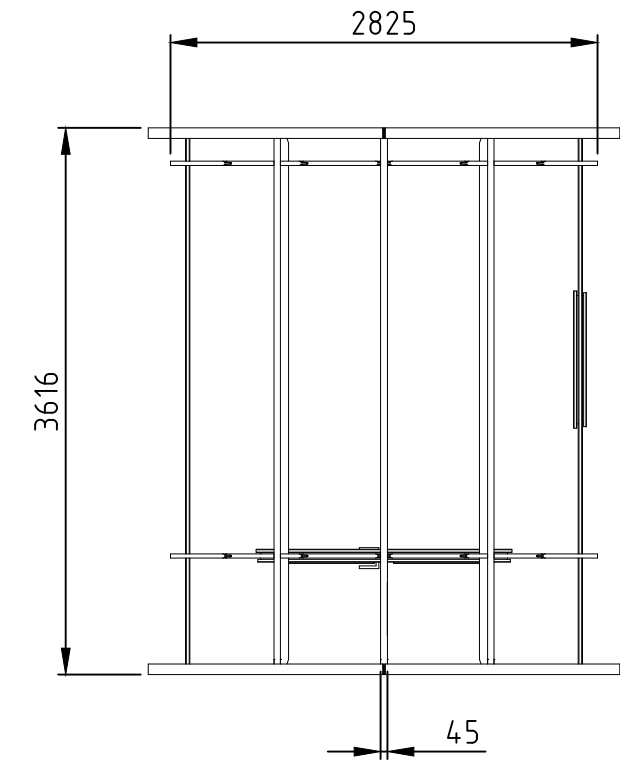
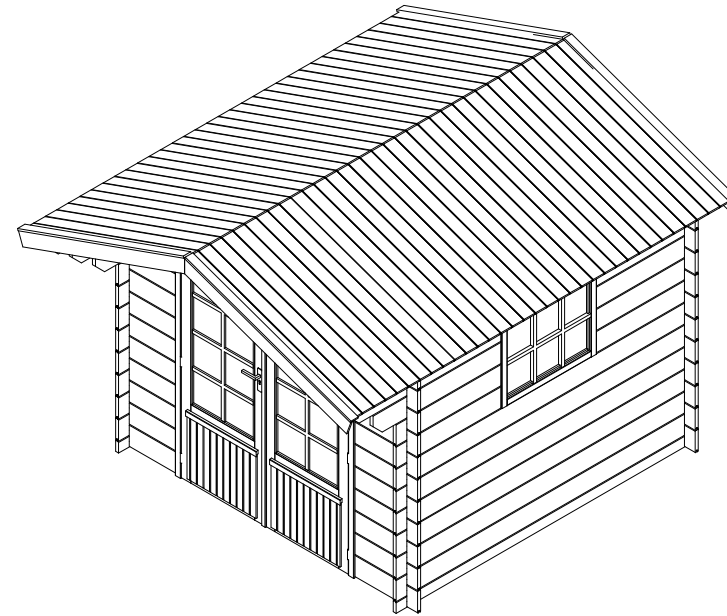
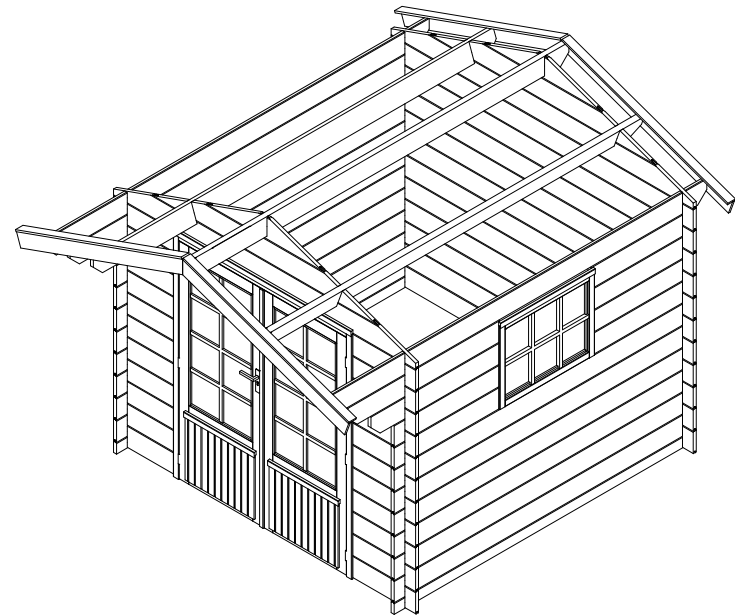

Overzicht gordingen

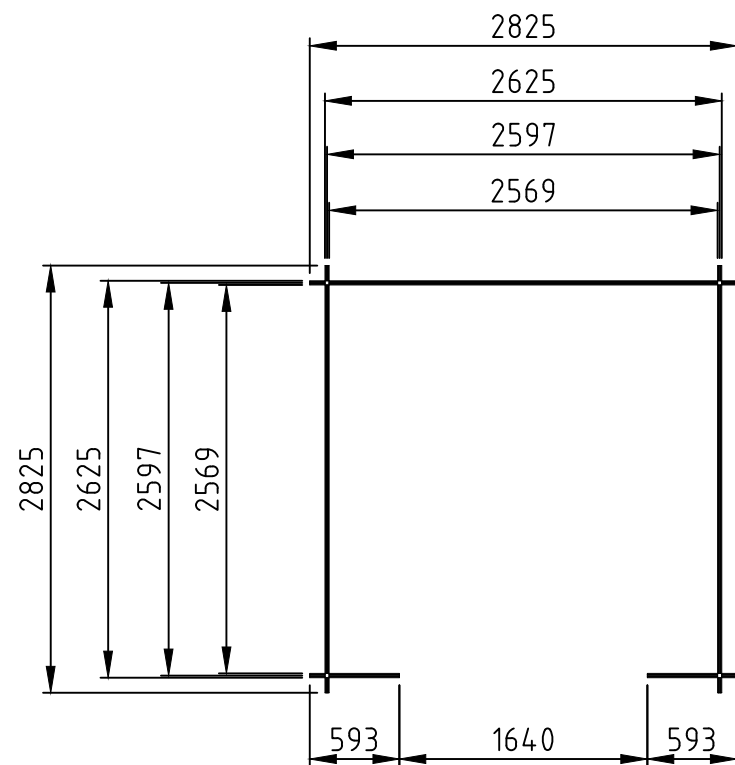

Fundatie gegevens

BEH. _							
ONDERDEEL							
Douglas Blokhut Curaçao							
MM	GET.		SCHAAL	FORMAAT	DAT.	TEK.NR.	
	DB		1:50	A3	30-11-'15	01	
www.woodvision.nl						ARTIKELNUMMER	
						40870	
						OPDRACHTGEVER	
						-	

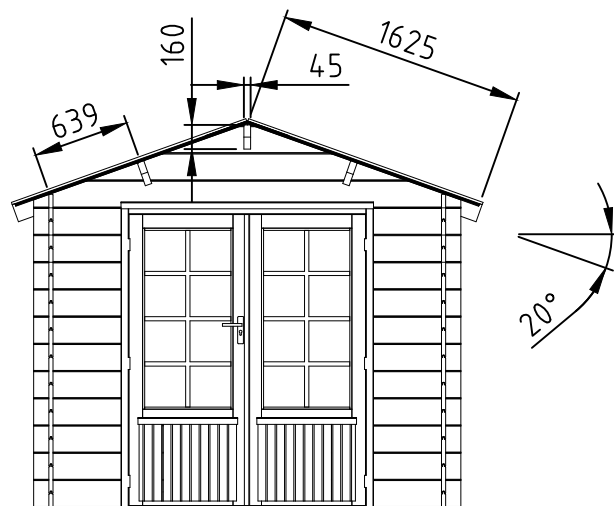
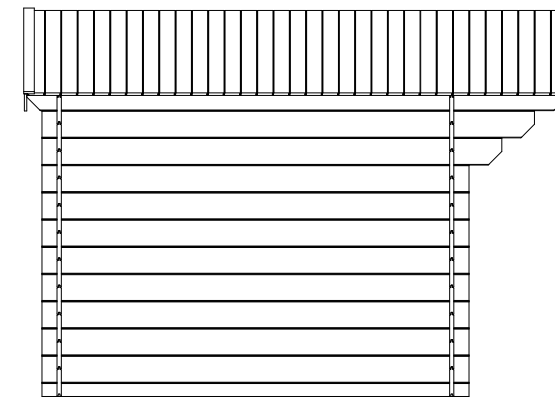
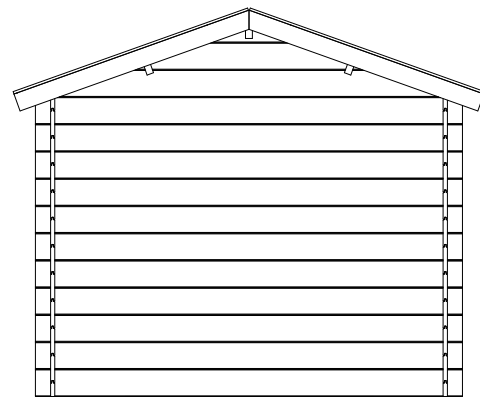
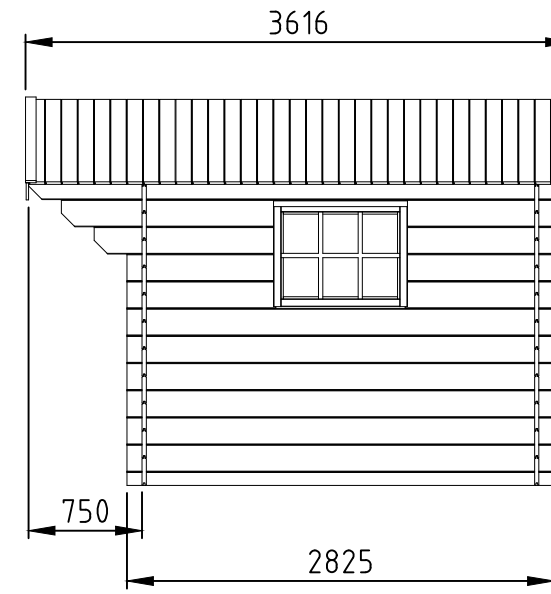
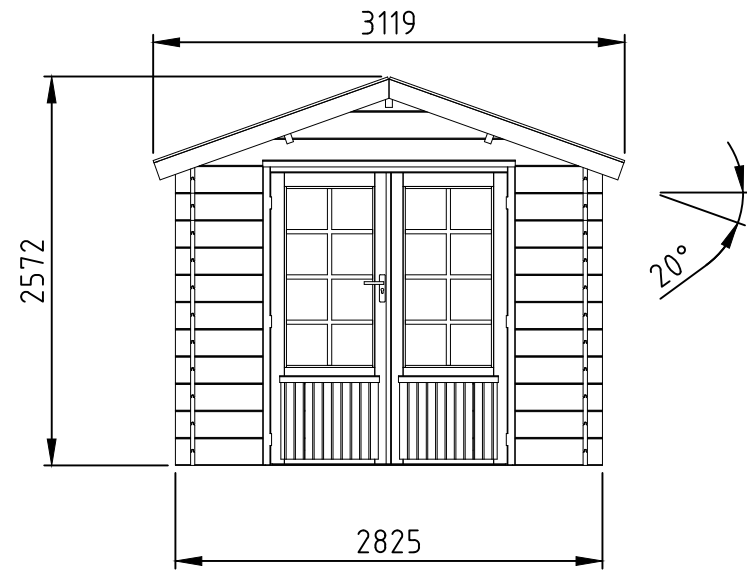

BEH. _						
ONDERDEEL						
Douglas Blokhut Curaçao						
MM	GET.		SCHAAL	FORMAAT	DAT.	TEK.NR.
	DB		1:50	A3	30-11-'15	02
www.woodvision.nl				ARTIKELNUMMER		
				40870		
				OPDRACHTGEVER		
				-		

Voorwand 28 dik DOUGLAS
WDB01-283
1x

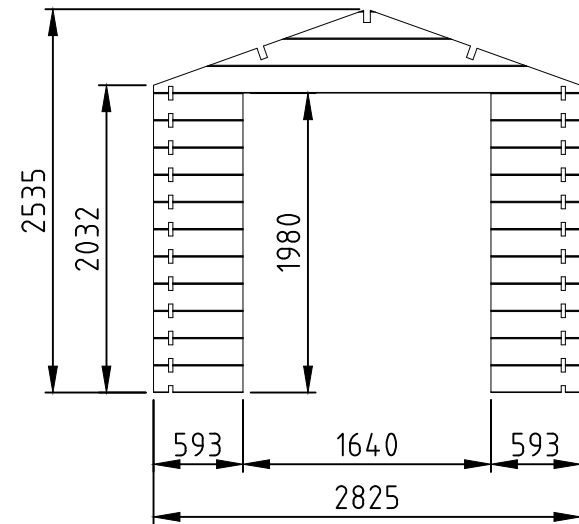

Achterwand 28 dik DOUGLAS
WDB03-283
1x

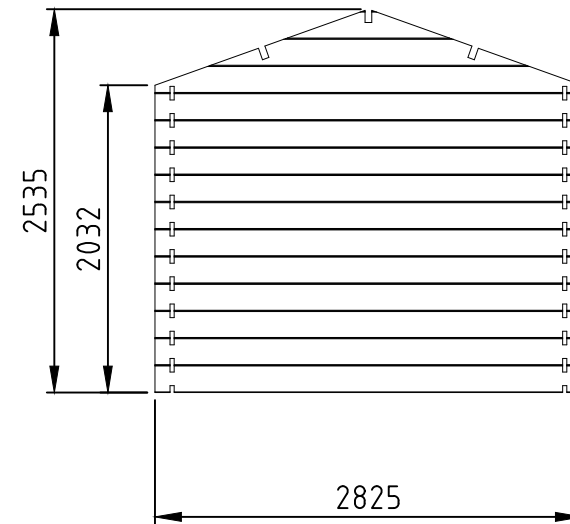

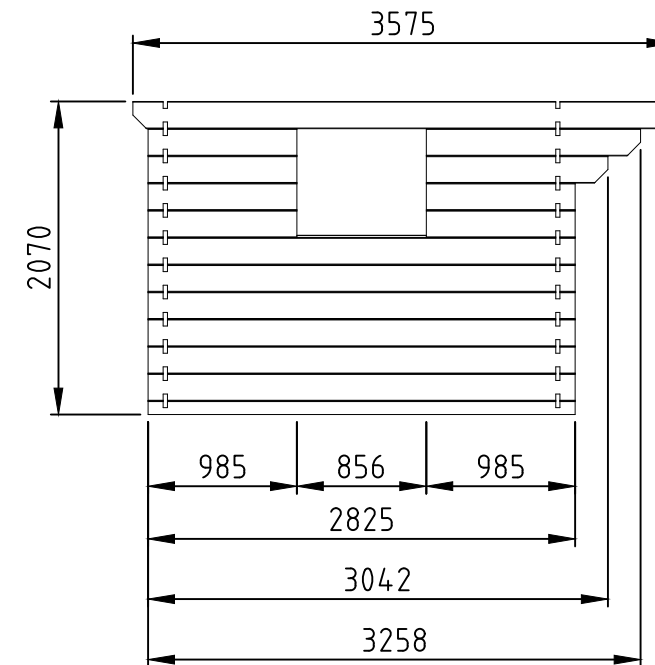

Zijwand met raam 28 dik DOUGLAS
WDB04-283
1x

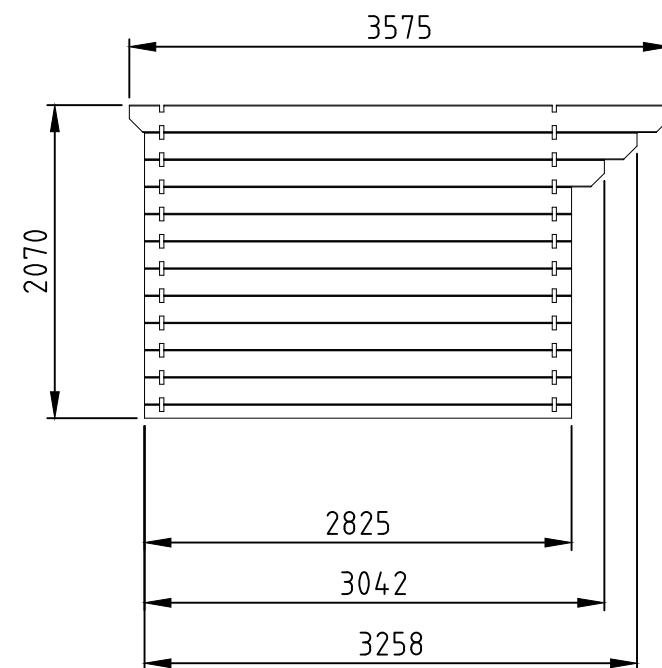

Zijwand dicht 28 dik DOUGLAS
WDB05-283
1x

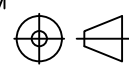

BEH. _									
ONDERDEEL									
Douglas Blokhut Curaçao									
MM		GET.			SCHAAL	FORMAAT	DAT.	TEK.NR.	
		DB			1:50	A3	30-11-'15	03	
www.woodvision.nl							ARTIKELNUMMER		
							40870		
							OPDRACHTGEVER		
							-		

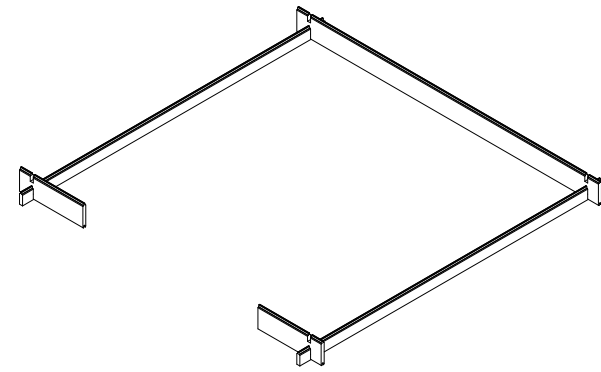

Eerste laag plaatsen.

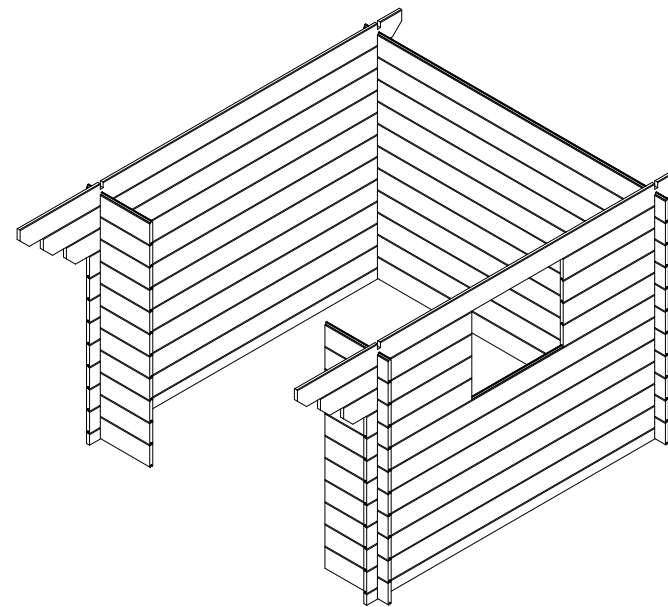

Wanden vol stapelen.

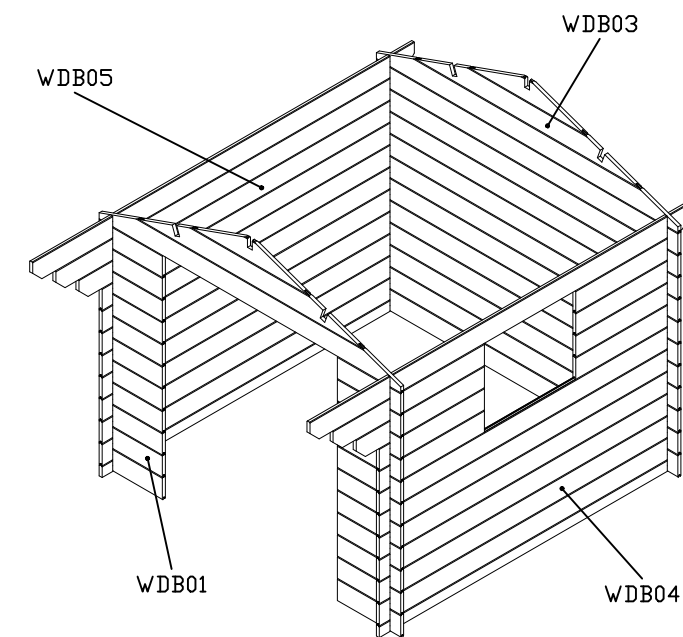

Gevelpunten plaatsen.

BEH. _							
ONDERDEEL							
Douglas Blokhut Curaçao							
MM		GET. DB		SCHAAL 1:50	FORMAAT A3	DAT. 30-11-'15	TEK.NR. 04
www.woodvision.nl							ARTIKELNUMMER 40870
					OPDRACHTGEVER		-

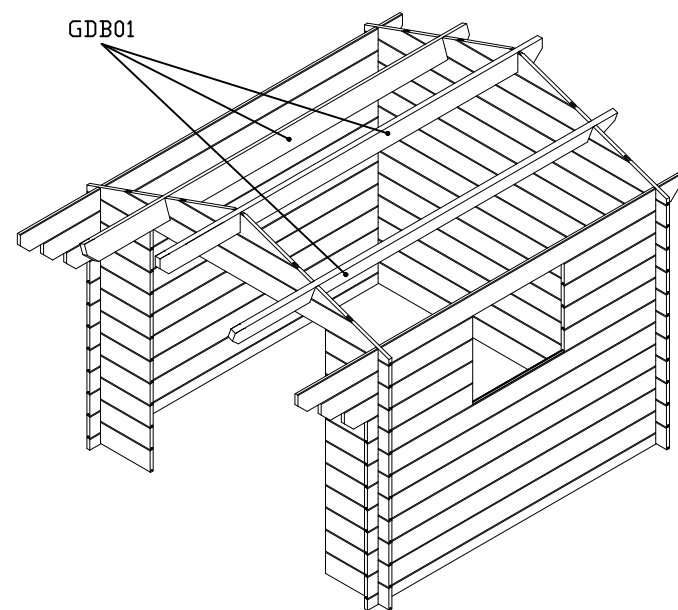

Gordingen plaatsen.

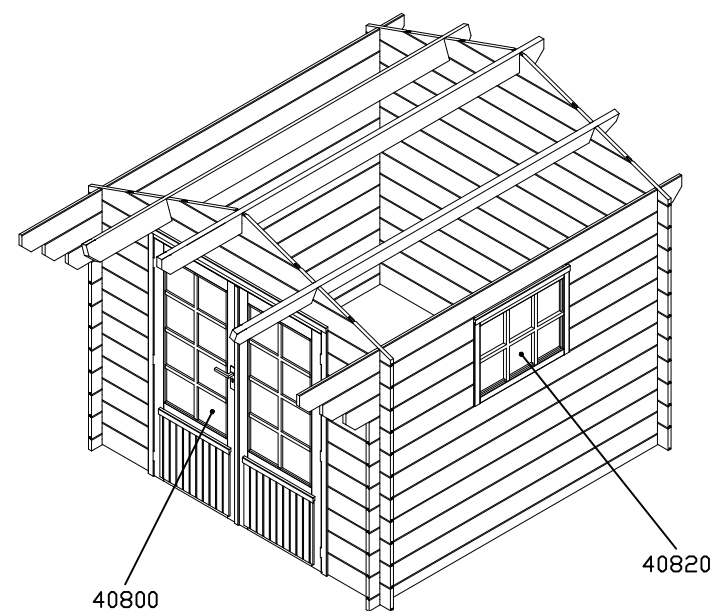

Raam en deur plaatsen.

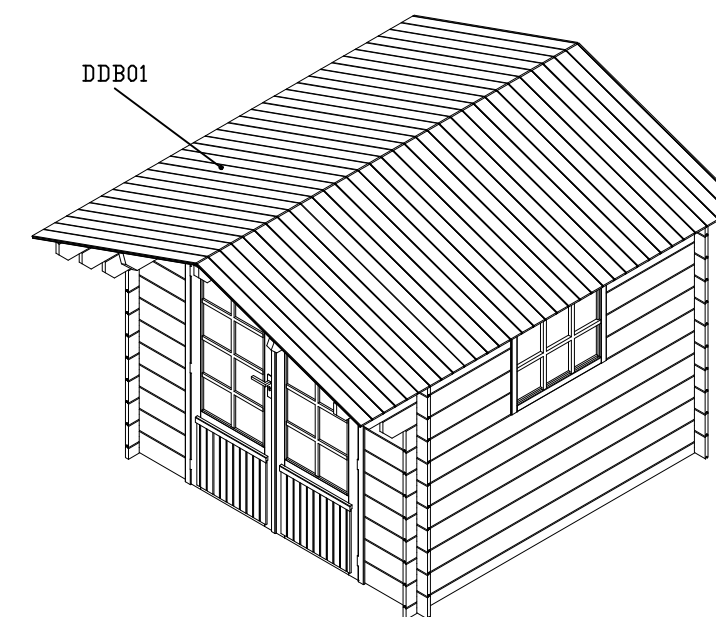

Dakplanken plaatsen.

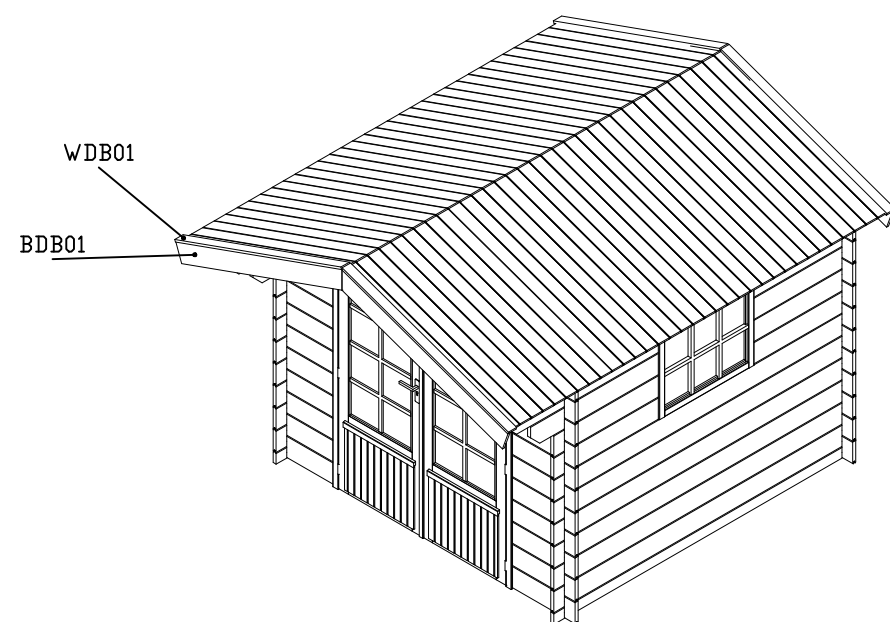

Dak afwerken met shingles, boeiboord en windveer.

BEH. _

ONDERDEEL

Douglas Blokhut Curaçao

MM

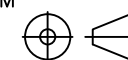

GET.

DB

SCHAAL

1:50

FORMAAT

A3

DAT.

30-11-'15

TEK.NR.

05

www.woodvision.nl

ARTIKELNUMMER

40870

OPDRACHTGEVER

-